







LIQUID CRYSTAL DISPLAY DRIVER CIRCUIT

Parts list:

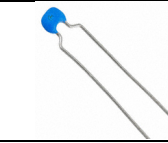
Part	Description	Quantity	Purchasing	Looks like
555 timer	8-pin integrated circuit	1	Digikey 497-1963-5-ND (\$0.33)	
100K Ω resistor	Brown-black-yellow	3	Digikey 100KQBK-ND (\$0.08)	
10K Ω resistor	Brown-black-orange	1	Digikey 10KQBK-ND (\$0.08)	
10 nF (10,000pF) capacitor		1	Digikey 490-3813-ND (\$0.33)	
100 nF capacitor (0.1 μ F)		1	Digikey 490-5401-ND (\$0.14)	
Battery 9V		1	Digikey P647-ND (\$1.98)	
Battery snap		1	Digikey 2239K-ND (\$0.97)	
LCD display	3-digit 7-segment	1	Digikey 67-1799-ND (\$2.57)	
Solderless breadboard		1	Digikey 923253-ND (\$22)	

Liquid Crystal Display Circuit Schematic

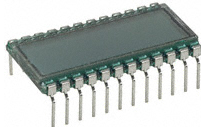
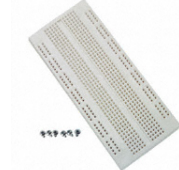
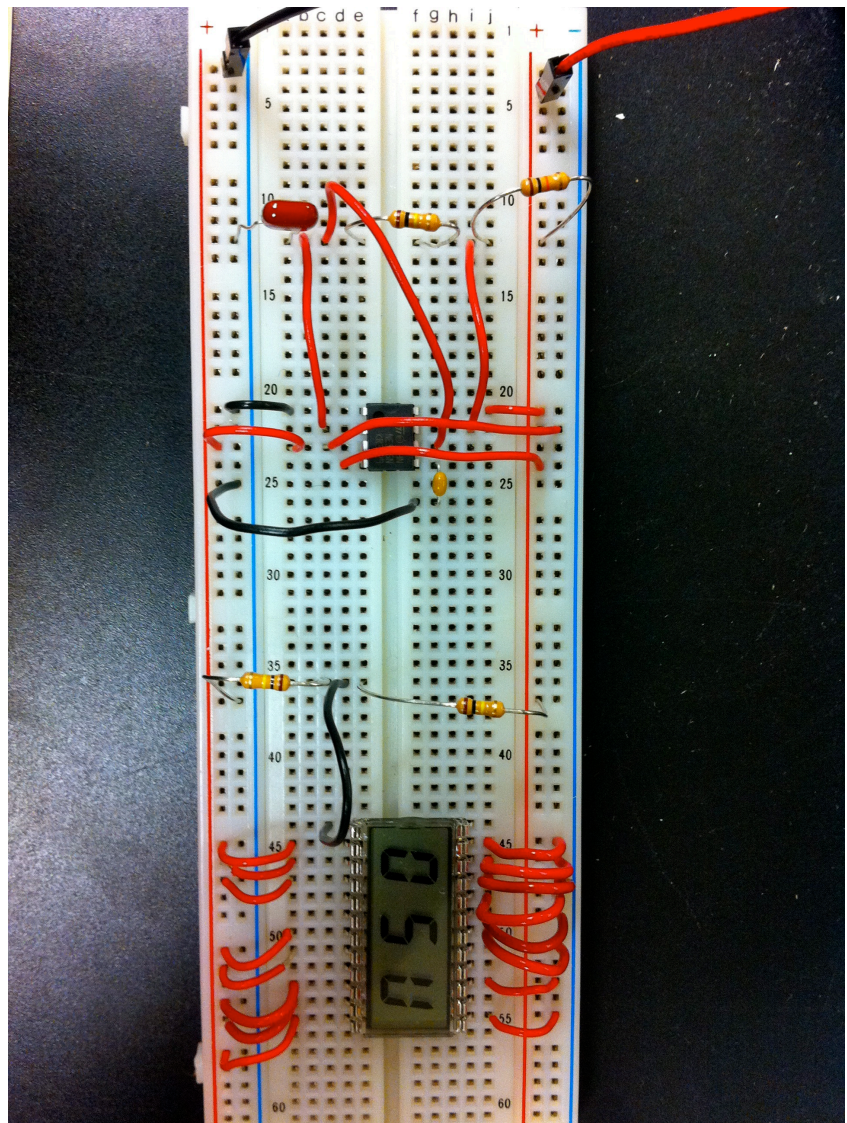
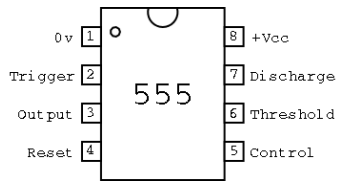
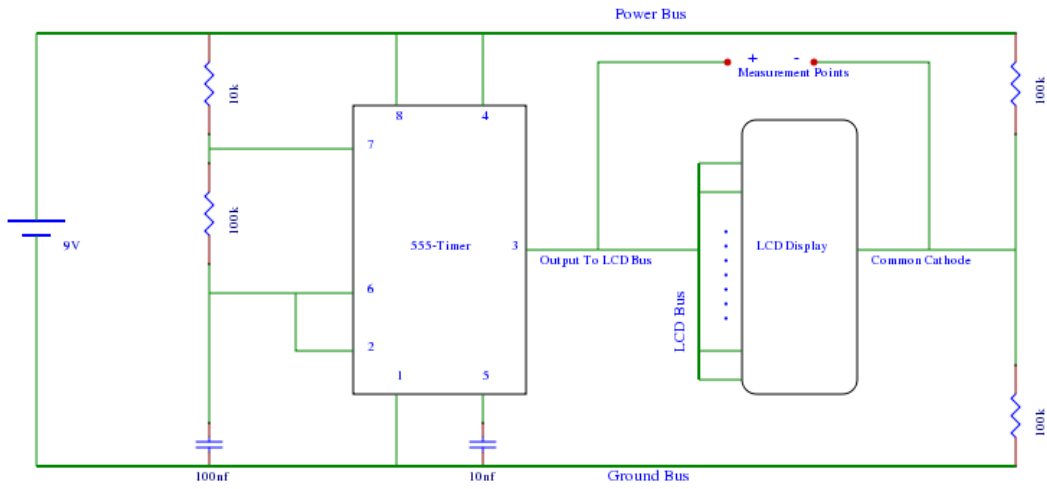

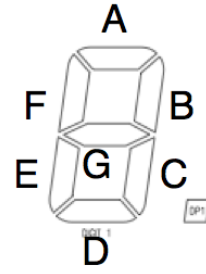
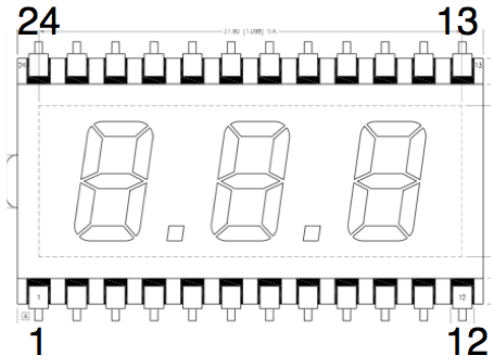

PIN	1	2	3	4	5	6	7	8	9	10	11	12
SEGMENT	COM	E1	D1	C1	DP1	E2	D2	C2	DP2	E3	D3	C3
PIN	13	14	15	16	17	18	19	20	21	22	23	24
SEGMENT	B3	A3	F3	G3	B2	A2	F2	G2	B1	A1	F1	G1